



# Eco Shell



Eco Shell – The Art of Sustainable Dining.

PRODUCT CATALOGUE



# About Us

# 关于我们

Eco Shell offers a full line of sustainable cutlery designed to support waste diversion goals while delivering reliable performance. Whether you need compostable, plant-based utensils or recycled content options, our cutlery is designed to meet the needs of any foodservice operation.

Our product portfolio extends beyond disposable serviceware to include hotel and guest amenities, allowing us to act as a true single-source supplier. We supply premium disposable paper cups, plates, and bowls; catering-grade and household aluminum foil; aluminum food containers; and a complete range of wet and dry wipes. In addition, we provide hotel amenities such as guest toiletries, hygiene kits, and in-room care items, developed to meet hospitality and airline service expectations. All products are manufactured using food-grade and skin-safe materials, ensuring safety, comfort, and performance in both guest-facing and operational environments.

Company Profile

## ABOUT US

16000+m<sup>2</sup>  
PRODUCTION  
FACILITIES



90\*40'HQ  
PER MONTH

120+  
EMPLOYEES



★ EUDR  
FSC  
BRC  
SEDEX

SINCE  
2014



BPI  
DIN CERTCO  
ABA



Our disposable products, including cups, plates, and food boxes, are designed with both functionality and sustainability in mind. Each item is manufactured using high-quality, food-grade raw materials that are safe for direct contact with food and beverages.

### Raw Materials Used:

- **Paperboard & Cardstock:** Our cups and boxes are primarily made from sustainably sourced paperboard, derived from FSC-certified forests. The paper is thick, durable, and resistant to moisture, making it ideal for both hot and cold beverages.
- **Plant-Based Coatings:** Instead of traditional plastic linings, we use biodegradable PLA (polylactic acid) coatings derived from corn starch or sugarcane. This ensures that the products remain leak-proof while being compostable.
- **Eco-Friendly Inks:** All prints and branding on our products use water-based, non-toxic inks that are safe for food contact and environmentally responsible.
- **Environmental Benefits:**
  - Biodegradable & Compostable:** Our products decompose naturally when disposed of in commercial composting facilities, reducing landfill waste. The plant-based coatings break down in months rather than decades.
- **Sustainably Sourced:** Paper and cardboard come from responsibly managed forests, ensuring minimal impact on deforestation and maintaining ecological balance.
- **Reduced Plastic Usage:** By replacing conventional plastic cups, lids, and containers with renewable materials, we significantly reduce microplastic pollution and carbon footprint.
- **Recyclable Options:** Depending on local waste management facilities, our paper cups and boxes can also be recycled after use, further contributing to a circular economy.
- **Production Process:**
  - Raw Material Preparation:** FSC-certified paperboard is selected and treated with water-based PLA coating for durability.
  - Cutting & Forming:** Sheets are cut and shaped into cups, plates, or boxes using precision machinery that minimizes waste.
  - Printing & Branding:** Eco-friendly inks are applied for logos or designs, ensuring visual appeal without compromising sustainability.
  - Quality Check & Packaging:** Every product is tested for strength, leakage, and durability before being packed for distribution.

# Product Range

产品范围

## ■ Paper Products

Paper Plates & Trays

Paper Cups

Cup Accessories

Paper Food Bowls

Paper Food Boxes

Plastic Cups & Lids

Paper Lids

Paper Bags

Compostable Cutlery

## ■ Aluminum Products

Aluminum Foil

Aluminum Foil Container

Aluminum Foil Jumbo Roll

Baking Paper

Wax Paper

Baking Paper Jumbo Roll

Cling Film Jumbo Roll

Cling Film

## ■ Technical data sheet (tds) ■ certifications

# Paper Plates & Trays 纸盘与托盘

Customized design of paper food tray, Elements provides customized multiple specifications, and we have two styles to choose from. One is used for packaging fresh fruit, which is generally used in large supermarkets and chain stores, and the other is used for packaging fast food snack bread, which is used for baking and fast food restaurants. You can provide us with design solutions according to your specific needs. If you have special specifications and the initial order quantity is met, Our door is customized for you.



## Eco-Friendly Material:

Made from certified paperboard, Tray Seal™ reduces plastic use by 85% and is fully recyclable, supporting a circular economy from start to finish.

## Advanced Freshness Protection:

Its molded fiberboard and high-barrier lining create a secure seal that prevents leaks and extends shelf life, matching the performance of traditional plastic trays.

## Easy & Cost-Effective Integration:

Designed for your existing equipment, Tray Seal™ integrates seamlessly into production lines without extra investment, offering a practical sustainable switch for all protein products.

### Tray One™

● White ● Kraft



Item No.	Description	Specifications(mm)	Pcs/Ctn	Carton Size(mm)	CTNS/20'GP	CTNS/40'HQ
TO00	#0 Tray One	139×80×24	1200	430×330×475	415	1009
TO01	#1 Tray One	160×92×24	1000	470×330×490	368	895
TO02	#2 Tray One	221×93×24	800	450×385×520	311	755
TO03	#3 Tray One	167×116×24	800	475×345×500	342	830
TO05	#5 Tray One	186×130×24	600	400×385×510	357	866
TO07	#7 Tray One	224×141×24	600	460×435×510	274	666
TO09	#9 Tray One	244×155×24	400	500×320×510	343	833
TO11	#11 Tray One	258×183×24	400	525×380×480	292	710

### Virgin PET/ Recycled PET Lids



Item No.	Description	Specifications(g)	Pcs/Ctn	Carton Size(mm)	CTNS/20'GP	CTNS/40'HQ
PETTO00	Tray One Lid #0	143×80×31	1200	440×540×360	327	795
PETTO01	Tray One Lid #1	163×92×32	1000	340×540×480	318	772
PETTO02	Tray One Lid #2	224×94×32	800	460×540×400	282	684
PETTO03	Tray One Lid #3	168×118×32	800	345×540×490	307	745
PETTO05	Tray One Lid #5	189×132×32	600	395×540×420	313	759
PETTO07	Tray One Lid #7	225×143×32	600	465×540×435	256	623
PETTO09	Tray One Lid #9	245×158×32	400	500×540×325	319	775
PETTO11	Tray One Lid #11	260×184×32	400	540×540×380	253	614



## Paper Tray

### Tray Shape

● White ● Kraft



Item No.	Description	Specifications(mm)	Pcs/Ctn	Carton Size(mm)	CTNS/20'GP	CTNS/40'HQ
TS350	350ml	123×120×35	600	490×375×430	354	860
TS450	450ml	158×121×35	600	495×480×420	280	681
TS500S	500ml Square	143×139×35	300	425×295×420	532	1291
TS650S	600ml Square	147×143×45	300	440×300×405	523	1271
TS750	750ml	177×133×45	300	410×360×430	441	1071
TS850S	850ml Square	148×146×60	300	445×300×405	518	1258
TS1000	1000ml	194×145×50	300	440×395×430	374	909
TS1200	1200ml	215×161×50	300	490×435×430	305	741
TS950TC	950ml Two Compartment	215×146×41	300	450×435×455	314	736

### Virgin PET/ Recycled PET Lids

● White ● Kraft



Item No.	Description	Specifications(mm)	Pcs/Ctn	Carton Size(mm)	CTNS/20'GP	CTNS/40'HQ
PETTS350	350ml Lid(Pending)	127×124×20	600	385×240×495	612	1486
PETTS450	450ml Lid(Pending)	162×125×20	600	490×240×500	476	1156
PETTS500S	500ml Lid	147×143×20	300	300×240×430	904	2196
PETTS650S	650ml Lid	150×150×50	300	475×375×325	483	1174
PETTS750	750ml Lid	180×135×30	300	380×335×435	505	1227
PETTS850S	850ml Lid(Pending)	152×150×20	300	310×240×455	827	2008
PETTS1000	1000ml Lid	198×149×30	300	415×340×475	417	1014
PETTS1200	1200ml Lid	219×165×30	300	460×330×520	354	861
PETTS950TC	950ml Lid	219×150×20	300	445×240×455	576	1399

# Paper Plates & Trays 纸盘与托盘



Disposable Kraft Paper Food Box  
White Paper Sushi Tray with  
Transparent PET Lid



Plastic Free Paper Sushi Tray Kraft  
Food Container



Recyclable Brown Paper Sushi Tray



100% Compostable Sushi Paper Tray

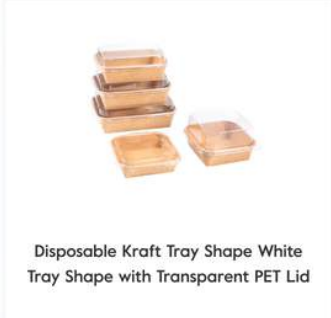

Disposable Kraft Tray Shape White  
Tray Shape with Transparent PET Lid



New Type Disposable Kraft Sushi Tray  
with Transparent PET Lids



Takeout Disposable Brown Paper  
Sushi Tray Kraft Paper Food Tray  
with Transparent PET Lid



Custom Food Grade Eco Friendly  
Sushi Tray With PET Transparent Lids



Custom Disposable Food Grade Sushi  
Container With PET Lids



Non PFAS Custom Size Disposable  
Round Food Paper Plate



Wholesale Non PFAS Eco Friendly  
Disposable Party Paper Food Plate



Zero PFAS Custom logo Disposable  
Party Kraft Food Round Paper Plates

# PAPER CUPS 纸杯

Our engineers have designed many styles of paper cups, including single-layer paper cups, hollow paper cups, corrugated paper cups, embossed paper cups, vending paper cups, etc., supporting the packaging of coffee, hot tea, juice, milk and other drinks. The paper cups produced by our company are environmentally friendly, biodegradable, compostable and recyclable. We strictly control every aspect of the production of paper cups to provide you with the best quality products.

## Paper Cups

### Aqueous Coating Paper Cups

● White ● Kraft



Item No.	Description	Top Dia×Bottom×Height(mm)	Pcs/Ctn	Carton Size(mm)	CTNS/20'GP	CTNS/40'HQ
AC-SW04	4oz	62×45×61	1000	325×260×335	989	2402
AC-SW06	6oz	80×53×79	1000	405×325×450	473	1148
AC-SW07	7oz	72×50×79	1000	370×300×340	742	1802
AC-SW08	8oz	80×56×94	1000	405×325×475	448	1088
AC-SW08S	8oz Squat	90×56×83	1000	455×365×455	371	900
AC-SW10	10oz Squat	90×60×95	1000	455×365×455	371	900
AC-SW12T	12oz Tall	80×52×120	1000	405×325×520	409	993
AC-SW12	12oz	90×58×108	1000	455×365×490	344	836
AC-SW16	16oz	90×58×138	1000	455×365×560	301	731
AC-SW20	20oz	90×60×160	1000	455×365×640	263	640

\* Other sizes available upon request



### Compostable PLA Paper Cups

● White ● Kraft



Item No.	Description	Top Dia×Bottom×Height(mm)	Pcs/Ctn	Carton Size(mm)	CTNS/20'GP	CTNS/40'HQ
PLA-SW04	4oz	62×45×61	1000	325×260×335	989	2402
PLA-SW06	6oz	80×53×79	1000	405×325×450	473	1148
PLA-SW07	7oz	72×50×79	1000	370×300×340	742	1802
PLA-SW08	8oz	80×56×94	1000	405×325×475	448	1088
PLA-SW08S	8oz Squat	90×56×83	1000	455×365×455	371	900
PLA-SW10	10oz Squat	90×60×95	1000	455×365×455	371	900
PLA-SW12T	12oz Tall	80×52×120	1000	405×325×520	409	993
PLA-SW12	12oz	90×58×108	1000	455×365×490	344	836
PLA-SW16	16oz	90×58×138	1000	455×365×560	301	731
PLA-SW20	20oz	90×60×160	1000	455×365×640	263	640

\* Other sizes available upon request



# PAPER CUPS

## Paper Cups

### Single Wall Paper Cups

● White ● Kraft



Item No.	Description	Top Dia×Bottom×Height(mm)	Pcs/Ctn	Carton Size(mm)	CTNS/20'GP	CTNS/40'HQ
SW2.5	2.5oz	51×36×50	5000	520×265×540	376	914
SW03	3oz	55×41×54	3000	340×285×550	525	1276
SW04	4oz	62×45×61	1000	325×260×335	989	2402
SW05	5oz	67×47×74	1000	350×280×355	805	1955
SW06	6oz	80×53×79	1000	405×325×450	473	1148
SW07	7oz	72×50×79	1000	370×300×340	742	1802
SW08	8oz	80×56×94	1000	405×325×475	448	1088
SW08S	8oz Squat	90×56×83	1000	455×365×455	371	900
SW09	9oz	76×53×95	1000	390×315×375	608	1476
SW10	10oz Squat	90×60×95	1000	455×365×455	371	900
SW12	12oz	90×58×108	1000	455×365×490	344	836
SW12T	12oz Tall	80×52×120	1000	405×325×520	409	993
SW16	16oz	90×58×138	1000	455×365×560	301	731
SW20	20oz	90×60×160	1000	455×365×640	263	640
SW22	22oz	90×61×170	1000	695×360×440	254	618



### Double Wall Paper Cups

● White ● Kraft



Item No.	Description	Top Dia×Bottom×Height(mm)	Pcs/Ctn	Carton Size(mm)	CTNS/20'GP	CTNS/40'HQ
DW07	7oz	73×52×81	500	545×300×370	463	1124
DW08	8oz	80×56×94	500	575×330×410	360	874
DW08S	8oz Squat	90×57×83	500	430×360×455	398	965
DW10	10oz Squat	90×60×95	500	480×365×455	351	853
DW12	12oz	90×58×108	500	455×365×515	327	795
DW16	16oz	90×58×138	500	455×365×680	248	602
DW16S	16oz Squat	90×62×125	500	610×365×445	283	686
DW20	20oz	90×60×160	500	820×365×460	203	494





### Ripple Wall Paper Cups

● White ● Kraft



Item No.	Description	Top Dia×Bottom×Height(mm)	Pcs/Ctn	Carton Size(mm)	CTNS/20'GP	CTNS/40'HQ
RW07	7oz	73×52×81	528	390×295×445	547	1328
RW08	8oz	80×56×94	500	475×325×410	442	1074
RW08S	8oz Squat	90×57×85	500	360×330×455	518	1258
RW10	10oz Squat	90×60×95	500	410×360×455	417	1013
RW12	12oz	90×58×108	500	455×360×455	376	912
RW16	16oz	90×58×138	500	575×360×455	297	722
RW20	20oz	90×60×160	500	710×450×365	240	583



### Embossed Wall Paper Cups

● White ● Kraft



Item No.	Description	Top Dia×Bottom×Height(mm)	Pcs/Ctn	Carton Size(mm)	CTNS/20'GP	CTNS/40'HQ
EDW08	8oz	80×56×94	500	360×320×410	593	1440
EDW12	12oz	90×58×108	500	360×350×450	494	1199
EDW16	16oz	90×58×138	500	460×360×450	376	913

### Paper Hot Cup Lids

● White ● Kraft



Item No.	Description	Dia(mm)	Pcs/Ctn	Carton Size(mm)	CTNS/20'GP	CTNS/40'HQ
PHL62	Paper Lid 4oz	62	1000	340×275×330	907	2204
PHL70	Paper Lid 7oz	70	1000	375×300×340	732	1778
PHL80	Paper Lid 8/8oz	80	1000	425×350×325	579	1407
PHL90	Paper Lid 10/12/16/20/22oz	90	1000	475×390×315	480	1165

### CPLA Hot Cup Lids

● Original ● Black



Item No.	Description	Dia(mm)	Pcs/Ctn	Carton Size(mm)	CTNS/20'GP	CTNS/40'HQ
CPLAHL62	CPLA Lid 4oz	62	2000	540×365×215	661	1605
CPLAHL80	CPLA Lid 8oz	80	1000	430×350×235	792	1923
CPLAHL90	CPLA Lid 10/12/16/20/22oz	90	1000	480×390×245	611	1483

### PS Hot Cup Lids

● White ● Black



Item No.	Description	Dia(mm)	Pcs/Ctn	Carton Size(mm)	CTNS/20'GP	CTNS/40'HQ
PSHL62	PS Lid 4oz	62	2000	515×350×280	564	1369
PSHL73	PS Lid 7oz	73	1000	400×170×430	958	2326
PSHL80	PS Lid 8oz	80	1000	475×185×440	724	1759
PSHL90	PS Lid 10/12/16/20/22oz	90	1000	505×195×470	605	1469

# PAPER CUPS 纸杯



22oz Custom Disposable Paper Coke Cup



China Factory Wholesale Disposable Colorful Embossed Wall Paper Cups



Custom Disposable Double Wall Paper Hot Cup



Custom Private Label Eco Friendly Disposable PLA Paper Coffee Cups



Plastic Free Water-based Coating Paper Cup



Double Wall Custom Logo Hot Drink Coffee Paper Cups



Customized Insulated Ripple Wall Coffee Paper Cup with Lid



Certified Compostable Customizable Paper Cup for Cold Drinks



Customized Compostable Paper Coffee Cups with Lids



Custom Disposable Hot Drink Ripple Wall Paper Cup



Plastic Free Aqueous Barrier Coating Paper Cup



Wholesale Bulk Kraft Disposable Takeaway Double Wall Coffee Paper Cup



Supplier Custom Disposable Paper Airline Coffee Cups



Custom 4oz Biodegradable PLA Lining Paper Hot Cups



Custom 12oz Water-based Coating Paper Coffee Cup



Custom Printed Disposable Individually Packaging Wrapped Cups



Custom Takeaway Disposable Ripple Wall Hot Drinks Coffee Paper Cups Supplier



Custom Printed Disposable Single Wall Paper Cups



Customization Disposable Paper Cups for Vending Machines



Custom Environmentally Friendly Airline Drinking Paper Cups



Custom Disposable Embossed Wall Paper Cups

With the development of the economy, the demand for food packaging is getting higher and higher, especially the sales of milk tea and coffee are increasing year by year. Elemnts provides paper cups and supporting products related to paper cups. They are paper cup sleeves and paper cup holders, which are very environmentally friendly and reliable. Recycling, able to support renewable functions, able to fulfill an environmental responsibility for your food delivery business

## Cup Accessories

### Cup Sleeves



Item No.	Description	Dia(mm)	Pcs/Ctn	Carton Size(mm)	CTNS/20'GP	CTNS/40'HQ
CS80	Cup Sleeve 8oz	80	1000	290×255×340	1114	2705
CS90	Cup Sleeve 10/12/16/20/22oz	90	1000	330×265×340	942	2287

### Spliced Portable Cup Holders



Item No.	Description	LengthxWidthxHeight(mm)	Pcs/Ctn	Carton Size(mm)	CTNS/20'GP	CTNS/40'HQ
SPCH2IN1	2-Cup	175×80×225(90)	300	530×280×265	711	1729

### Cup Holders



Item No.	Description	LengthxWidthxHeight(mm)	Pcs/Ctn	Carton Size(mm)	CTNS/20'GP	CTNS/40'HQ
CH2IN1	2-Cup (2 in 1)	225×110×47	600	480×360×460	352	855
CH4IN1	4-Cup (4 in 1)	225×225×47	300	450×370×470	358	869

### Cup Holders



Item No.	Description	LengthxWidthxHeight(mm)	Pcs/Ctn	Carton Size(mm)	CTNS/20'GP	CTNS/40'HQ
CH2SP1	2-Cup (2 split 1)	220×110×45	600	460×360×460	368	855
CH4SP2	4-Cup (4 split 2)	230×180×45	400	420×420×460	331	855

## Regular Paper Straws ● White ● Kraft



Item No.	Dia(mm)	Length(mm)	Pcs/Ctn	Carton Size(mm)	CTNS/20'GP	CTNS/40'HQ
PS06	Dia 6mm	197/210/230/240	10000	580×320×420	359	872
PS08	Dia 8mm	197/210/230/240	5000	480×370×420	375	912
PS10	Dia 10mm	197/210/230/240	5000	650×440×420	233	566
PS12	Dia 12mm	197/210/230/240	5000	730×510×420	179	435

## Flexible Paper Straws ● White ● Kraft



Item No.	Dia(mm)	Length(mm)	Pcs/Ctn	Carton Size(mm)	CTNS/20'GP	CTNS/40'HQ
PS06	Dia 6mm	197/210/230/240	10000	580×320×420	359	872
PS08	Dia 8mm	197/210/230/240	5000	480×370×420	375	912
PS10	Dia 10mm	197/210/230/240	5000	650×440×420	233	566
PS12	Dia 12mm	197/210/230/240	5000	730×510×420	179	435

## Sharp Edged Paper Straws ● White ● Kraft



Item No.	Dia(mm)	Length(mm)	Pcs/Ctn	Carton Size(mm)	CTNS/20'GP	CTNS/40'HQ
PS06	Dia 6mm	197/210/230/240	10000	580×320×420	359	872
PS08	Dia 8mm	197/210/230/240	5000	480×370×420	375	912
PS10	Dia 10mm	197/210/230/240	5000	650×440×420	233	566
PS12	Dia 12mm	197/210/230/240	5000	730×510×420	179	435

## Individually Wrapped Paper Straws ● White ● Kraft



Item No.	Dia(mm)	Length(mm)	Pcs/Ctn	Carton Size(mm)	CTNS/20'GP	CTNS/40'HQ
PS06	Dia 6mm	197/210/230/240	10000	580×320×420	359	872
PS08	Dia 8mm	197/210/230/240	5000	480×370×420	375	912
PS10	Dia 10mm	197/210/230/240	5000	650×440×420	233	566
PS12	Dia 12mm	197/210/230/240	5000	730×510×420	179	435

# PAPER FOOD BOWLS 纸食品碗

Customized disposable food paper bowls. In terms of raw materials, we can provide white paper bowls, bamboo pulp paper bowls and kraft paper bowls; On the coating, we custom PE coating paper bowls, PP coating paper bowls, which can be heated by microwave, PET coating paper bowls that can be heated by oven, as well as eco friendly PLA coated paper bowls, water based coated paper bowls, which can be composting, biodegradable and recyclable; Provide suitable cardboard cover and PET cover;

## Paper Food Bowls

### Paper Soup Containers



● White ● Kraft



Item No.	Description	Top Dia×Bottom×Height(mm)	Pcs/Ctn	Carton Size(mm)	CTNS/20'GP	CTNS/40'HQ
SC06	6oz	98×79×51	500	490×200×390	725	1767
SC08	8oz	98×82×57	500	495×200×400	705	1717
SC12T	12oz Tall	98×74×74	500	495×200×505	560	1360
SC16T	16oz Tall	98×71×99	500	495×200×510	554	1346
SC10	10oz	115×97×46	500	585×240×460	434	1053
SC12	12oz	115×91×60	500	585×240×410	486	1181
SC16	16oz	115×91×74	500	585×240×490	407	988
SC24	24oz	115×89×113	500	585×240×570	350	850
SC32	32oz	115×89×136	500	585×240×690	289	702



### Stackable Cardboard Lids

● White ● Kraft



Item No.	Description	Dia(mm)	Pcs/Ctn	Carton Size(mm)	CTNS/20'GP	CTNS/40'HQ
SSCL98	Stackable Lid Dia-98	98	500	515×210×655	395	959
SSCL115	Stackable Lid Dia-115	115	500	600×245×645	295	717

### PP Lids



Item No.	Description	Dia(mm)	Pcs/Ctn	Carton Size(mm)	CTNS/20'GP	CTNS/40'HQ
PPSCL98	PP Lid Dia-98	98	500	510×210×420	622	1512
PPSCL115	PP Lid Dia-115	115	500	620×360×260	482	1172

### PET Lids



Item No.	Description	Dia(mm)	Pcs/Ctn	Carton Size(mm)	CTNS/20'GP	CTNS/40'HQ
PETSCL115-F	PET Flat Lid Dia-115	115	500	605×280×250	661	1605
PETSCL115-D	PET Dome Lid Dia-115	115	500	605×280×250	712	1729

## Paper Food Bowls

### Paper Salad Bowls

● White ● Kraft



Item No.	Description	Top Dia×Bottom×Height(mm)	Pcs/Ctn	Carton Size(mm)	CTNS/20'GP	CTNS/40'HQ
SB500	500ml	149×129×49	300	460×310×500	393	954
SB750	750ml	149×128×59	300	460×310×515	381	926
SB1000	1000ml	149×128×78	300	460×310×530	370	900
SB1150	1150ml	167×145×69	300	510×340×520	311	754
SB1300	1300ml	183×160×68	300	550×370×560	246	597
SB1500	1500ml	183×159×78	300	550×370×580	237	576



### Cardboard Lids

● White ● Kraft



Item No.	Description	Dia(mm)	Pcs/Ctn	Carton Size(mm)	CTNS/20'GP	CTNS/40'HQ
CBSBL149	Cardboard Lid 500/750/1000ml	149	300	660×320×480	276	671
CBSBL167	Cardboard Lid 1150ml	167	300	660×360×525	224	545
CBSBL183	Cardboard Lid 1300/1500ml	183	300	680×410×580	173	421

### PET Lids



Item No.	Description	Dia(mm)	Pcs/Ctn	Carton Size(mm)	CTNS/20'GP	CTNS/40'HQ
PETSBL149	PET Lid 500/750/1000ml	149	300	480×300×320	608	1476
PETSBL167	PET Lid 1150ml	167	300	525×265×355	567	1377
PETSBL183	PET Lid 1300/1500ml	183	300	580×400×310	389	945

### PLA Lids



Item No.	Description	Dia(mm)	Pcs/Ctn	Carton Size(mm)	CTNS/20'GP	CTNS/40'HQ
PLASBL149	PLA Lid 500/750/1000ml	149	400	650×350×340	361	879
PLASBL183	PLA Lid 1300/1500ml	183	200	410×410×360	462	1123

### PP Lids



Item No.	Description	Dia(mm)	Pcs/Ctn	Carton Size(mm)	CTNS/20'GP	CTNS/40'HQ
PPSBL149	PP Lid 500/750/1000ml	149	300	490×330×370	488	1137
PPSBL167	PP Lid 1150ml	167	300	540×265×340	575	1398
PPSBL183	PP Lid 1300/1500ml	183	300	580×400×370	326	792

### PP Insert Trays



Item No.	Description	Dia(mm)	Pcs/Ctn	Carton Size(mm)	CTNS/20'GP	CTNS/40'HQ
PPSBT1C	1 Compartment Tray for 500/750/1000ml	149	600	450×300×310	669	1625



Item No.	Description	Dia(mm)	Pcs/Ctn	Carton Size(mm)	CTNS/20'GP	CTNS/40'HQ
PPSBT2C	2 Compartment Tray for 500/750/1000ml	149	600	450×400×310	502	1219



Item No.	Description	Dia(mm)	Pcs/Ctn	Carton Size(mm)	CTNS/20'GP	CTNS/40'HQ
PPSBT3C	3 Compartment Tray for 500/750/1000ml	149	600	450×400×310	502	1219

## Paper Food Bowls

### Takeaway Paper Noodle Bowls

● White ● Kraft



Item No.	Description	Top Dia×Bottom×Height(mm)	Pcs/Ctn	Carton Size(mm)	CTNS/20'GP	CTNS/40'HQ
NB700	700ml	139×119×65	1000	565×425×565	206	501
NB850	850ml	139×112×82	600	565×425×635	184	446
NB1000	1000ml	139×108×96	600	565×425×590	198	480
NB1200	1200ml	139×108×115	600	565×425×610	191	464

### PET Lids



Item No.	Description	Dia(mm)	Pcs/Ctn	Carton Size(mm)	CTNS/20'GP	CTNS/40'HQ
PETNBL139	PET Lid 700/850/1000/1200ml	139	300	460×320×305	624	1515

### PP Lids



Item No.	Description	Dia(mm)	Pcs/Ctn	Carton Size(mm)	CTNS/20'GP	CTNS/40'HQ
PPNBL139	PP Lid 700/850/1000/1200ml	139	300	440×390×310	526	1278

### PP Insert Trays



Item No.	Description	Dia(mm)	Pcs/Ctn	Carton Size(mm)	CTNS/20'GP	CTNS/40'HQ
PPNBT2L	2 Layer Tray 700/850/1000/1200m	139	300	710×320×470	262	637

### Portion Cups ● White ● Kraft



Item No.	Description	Top Dia×Bottom×Height(mm)	Pcs/Ctn	Carton Size(mm)	CTNS/20'GP	CTNS/40'HQ
PC005	0.5oz	37×23×22	5000	320×195×320	1402	3405
PC0075	0.75oz	39×26×27	5000	325×215×335	1196	2905
PC01	1oz	43×30×30	5000	360×225×345	1002	2433
PC01S	1oz Squat	60×43×14	5000	490×310×310	595	1444
PC0125	1.25oz	50×35×31	5000	430×270×350	689	1673
PC0125S	1.25oz Squat	84×50×19	5000	505×330×335	502	1218
PC02	2oz	56×40×35	5000	455×285×345	626	1520
PC0325	3.25oz	72×50×41	5000	605×375×360	343	833

# Paper food bowls

# 紙食品碗

## Paper Food Bowls

### Rectangular Paper Bowls

● White ● Kraft



Item No.	Description	Length×Width×Height(mm)	Pcs/Ctn	Carton Size(mm)	CTNS/20'GP	CTNS/40'HQ
RCPB580	580ml	(168×120)×(150×102)×45	300	375×350×495	430	1046
RCPB750	750ml	(168×120)×(150×102)×55	300	375×350×500	426	1036
RCPB880	880ml	(168×120)×(146×98)×65	300	375×350×515	414	1006
RCPB1000	1000ml	(168×120)×(146×98)×75	300	375×350×525	406	986



### PET Lids



Item No.	Description	Length×Width(mm)	Pcs/Ctn	Carton Size(mm)	CTNS/20'GP	CTNS/40'HQ
PETRCL168	PET Lid 580/750/880/1000ml	168×120	300	540×340×270	564	1371

### PP Lids



Item No.	Description	Length×Width(mm)	Pcs/Ctn	Carton Size(mm)	CTNS/20'GP	CTNS/40'HQ
PPRCL168	PP Lid 580/750/880/1000ml	168×120	300	540×340×270	564	1371

### Paper Lid



Item No.	Description	Length×Width(mm)	Pcs/Ctn	Carton Size(mm)	CTNS/20'GP	CTNS/40'HQ
PRCL168	Paper Lid 580/750/880/1000ml	168×120	300	525×495×350	307	747

### Square Paper Bowls

● White ● Kraft



Item No.	Description	Top×Bottom×Height(mm )	Pcs/Ctn	Carton Size(mm)	CTNS/20'GP	CTNS/40'HQ
SQPB500	500ml	130×110×47	300	400×270×480	540	1311
SQPB650	650ml	130×108×60	300	415×275×485	505	1228
SQPB750	750ml	170×148×45	300	530×355×525	283	688
SQPB1000	1000ml	170×146×55	300	530×355×540	275	669
SQPB1200	1200ml	170×144×65	300	530×355×540	275	669
SQPB1400	1400ml	170×142×75	300	530×355×545	273	663



### PET Lids

Item No.	Description	Length×Width(mm)	Pcs/Ctn	Carton Size(mm)	CTNS/20'GP	CTNS/40'HQ
PETSQ130	PET Lid 500/650ml	130×130	300	420×290×290	792	1925
PETSQ170	PET Lid 750/1000/1200/1400ml	170×170	300	545×310×370	447	1087



### PP Lids

Item No.	Description	Length×Width(mm)	Pcs/Ctn	Carton Size(mm)	CTNS/20'GP	CTNS/40'HQ
PPSQL130	PP Lid 500/650ml	130×130	300	430×350×290	641	1558
PPSQL170	PP Lid 750/1000/1200/1400ml	170×170	300	545×345×370	402	977



### Paper Lid

Item No.	Description	Length×Width(mm)	Pcs/Ctn	Carton Size(mm)	CTNS/20'GP	CTNS/40'HQ
PSQ130	Paper Lid 500/650ml	130×130	300	550×415×335	366	889
PSQ170	Paper Lid 750/1000/1200/1400ml	170×170	300	720×520×360	207	504



# PAPER FOOD BOWLS 纸食品碗



Conical Paper Bowl



Custom China manufacturer Non PFAS Rectangle Disposable Kraft Paper Square Bowl



Custom Disposable Fast Food Salad Paper Bowl With PP Food Tray



Custom Paper Soup Cup Takeaway Hot Food Container with Lid



Takeaway Disposable Rectangular Paper Bowl with Lid



Factory Disposable Takeaway Paper Salad Bowl with Lid



Disposable Paper Sauce Cup Custom Portion Cup with Lid



Non PFAS Custom Compostable Disposable Takeaway Paper Salad Bowls



OEM Custom Food Grade Disposable Paper Soup Bowl Container With Lids



Disposable Food Grade Kraft Paper Salad Bowl With Compartments Trays



Custom Food Grade Biodegradable Disposable Food Paper Salad Bowl



Food Grade Biodegradable Disposable Kraft Paper Portion Cup with Lids

# PAPER FOOD BOWLS 纸食品碗



Custom Zero PFAS Biodegradable Disposable Food Grade Paper Salad Bowl



Custom Disposable Takeaway Plain White Paper Noodle Bowl With Lids



Zero PFAS Custom Service Logo Takeaway Bamboo Fiber Plup Paper Disposable Bowl



Wholesale Non PFAS Eco Friendly Disposable Food Grade 2oz 3oz 4oz Paper Sauce Cup With Lids



Custom Microwaveable & Ovenable Takeaway Disposable PET Coating Paper Bowl



China Supplier Non PFAS Rectangle Disposable Kraft Paper Salad Bowl



OEM Custom Food Grade Disposable Paper Sauce Portion Cup Container



Custom New Style Food Grade Disposable Paper Sauce Cup Biodegradable Portion Cups



Eco Friendly Disposable Waterproof Kraft Soup Cup

# PAPER FOOD BOXES

## 纸食品盒

OEM customized wholesale packaging lunch boxes, we provide packaging boxes customized with # 1, # 2, # 3, # 5, # 8 style paper boxes, PE, PP microwave heating, PET oven heating, and environmentally friendly degradable PLA, non-plastic coating in terms of surface coating. Regarding the types of lunch boxes, we provide window type, split type, single-piece turnbuckle type packaging boxes to meet your customization needs. If you need to know more about customization, Welcome to contact us.



Factory Custom Takeaway Paper Lunch Boxes With PET Window



Manufacturer Zero PFAS Custom Food Grade Compartment Paper Lunch Boxes



Wholesale Non PFAS Takeaway Food Grade Disposable Biodegradable Paper Food Box



Takeout Recyclable Food Brown Box Disposable Kraft Lunch Box with Clear Window



Non PFAS Wholesale Disposable Food Grade Take Out Paper Lunch Box



Non PFAS OEM Custom Disposable Kraft Bamboo Paper Lunch Box



Disposable Hot Food Box with Transparent Window



Custom Disposable Bento Window Lunch Boxes



Wholesale Disposable Kraft Takeaway Bio-Boxes

### Takeaway Bio-Boxes

● White ● Kraft



Item No.	Description	Top×Bottom×Height(mm)	Pcs/Ctn	Carton Size(mm)	CTNS/20'GP	CTNS/40'HQ
TB01	#1	(130×105)×(113×90)×65	450	570×360×460	297	720
TB02	#2	(215×158)×(197×140)×48	200	430×350×485	384	932
TB03	#3	(215×158)×(197×140)×65	200	500×350×490	327	793
TB04	#4	(222×163)×(197×140)×90	160	480×360×510	318	772
TB08	#8	(171×142)×(152×120)×65	300	560×390×450	285	692

### Compartment Bio-Boxes

● White ● Kraft



Item No.	Description	Top×Bottom×Height(mm)	Pcs/Ctn	Carton Size(mm)	CTNS/20'GP	CTNS/40'HQ
TB2C	Small	(168×135)×(151×120)×50	200	580×390×310	399	970

### Window Lunch Boxes

● White ● Kraft



Item No.	Description	Top×Bottom×Height(mm)	Pcs/Ctn	Carton Size(mm)	CTNS/20'GP	CTNS/40'HQ
WLBXS	X-Small	(134×102)×(120×88)×37	300	380×305×375	644	1565
WLBS	Small	(166×115)×(150×100)×45	300	400×380×390	472	1147
WLBM	Medium	(197×137)×(180×120)×50	300	455×440×485	288	700
WLBL	Large	(195×158)×(170×135)×60	300	450×440×530	267	648
WLBXL	X-Large	(218×158)×(195×135)×60	300	485×480×535	225	546
WLBXXL	XX-Large	(218×163)×(195×140)×65	300	500×480×535	218	530

### Regular Lunch Boxes

● White ● Kraft



Item No.	Description	Top×Bottom×Height(mm)	Pcs/Ctn	Carton Size(mm)	CTNS/20'GP	CTNS/40'HQ
LBXS	X-Small	(134×102)×(120×88)×37	300	380×305×375	644	1565
LBS	Small	(166×115)×(150×100)×45	300	400×380×390	472	1147
LBM	Medium	(197×137)×(180×120)×50	300	455×440×485	288	700
LBL	Large	(195×158)×(170×135)×60	300	450×440×530	267	648
LBXL	X-Large	(218×158)×(195×135)×60	300	485×480×535	225	546
LBXXL	XX-Large	(218×163)×(195×140)×65	300	500×480×535	218	530

### Hot Food Boxes

● White ● Kraft



Item No.	Description	Top×Bottom×Height(mm)	Pcs/Ctn	Carton Size(mm)	CTNS/20'GP	CTNS/40'HQ
HFBS	Small	(155×115)×(140×95)×60	360	600×360×390	332	807

## Paper Food Boxes

### Noodle Boxes

● White ● Kraft



Item No.	Description	Specifications(mm)	Pcs/Ctn	Carton Size(mm)	CTNS/20'GP	CTNS/40'HQ
NB16	16oz	(75×93)×(53×75)×86	500	465×430×420	333	809
NB26	26oz	(95×105)×(67×80)×105	500	500×460×430	283	687

### Chip Containers

● White ● Kraft



Item No.	Description	Specifications(mm)	Pcs/Ctn	Carton Size(mm)	CTNS/20'GP	CTNS/40'HQ
FFC-T	Triangular Chip Containers	152×145×190	1000	525×390×190	719	1747
FFC-S	Square Chip Containers	130×130×65	480	545×350×190	772	1876

Plastic cups are containers made from various types of plastic materials. Like PET, PLA etc. They are widely used for serving both hot and cold beverages and are popular in various settings, including homes, offices, parties, restaurants, and outdoor events.

## Plastic Clear Cups

### PLA Clear Cold Cups & Containers



Item No.	Description	Top Dia×Bottom×Height(mm)	Pcs/Ctn	Carton Size(mm)	CTNS/20'GP	CTNS/40'HQ
PLACC12	12oz	98×56×103	1000	510×410×400	335	813
PLACC16	16oz	98×61×118	1000	510×410×430	311	756
PLACC20	20oz	98×61×139	1000	510×410×540	248	602
PLACC24	24oz	98×61×150	1000	510×410×510	263	638

### PLA Lids



Item No.	Description	Dia(mm)	Pcs/Ctn	Carton Size(mm)	CTNS/20'GP	CTNS/40'HQ
PLACL98F	PLA Flat Lid 12/16/20/24oz	98	1000	530×210×430	585	1421
PLACL98D	PLA Dome Lid 12/16/20/24oz	98	1000	530×280×430	439	1066
PLACL98S	PLA Strawless Lid 12/16/20/24oz	98	1000	530×230×430	534	1297

### PET Clear Cold Cups & Containers



Item No.	Description	Top Dia×Bottom×Height(mm)	Pcs/Ctn	Carton Size(mm)	CTNS/20'GP	CTNS/40'HQ
PETCC12	12oz	98×59×89	1000	505×405×355	386	937
PETCC14	14oz	98×60×108	1000	505×405×425	322	782
PETCC16	16oz	98×65×123	1000	505×405×435	315	764
PETCC20	20oz	98×64×135	1000	505×405×445	308	747
PETCC24	24oz	98×57×153	1000	505×405×465	294	715

### PET Lids



Item No.	Description	Dia(mm)	Pcs/Ctn	Carton Size(mm)	CTNS/20'GP	CTNS/40'HQ
PETCL98F	PET Flat Lid	98	1000	420×200×510	654	1587
PETCL98D	PET Dome Lid 12/14/16/18/20/24	98	1000	415×250×510	529	1285
PETCL98S	PET Strawless Lid 12/14/16/18/20	98	1000	425×255×520	497	1207

# PAPER LIDS

# 纸杯盖

We accept 62mm 70mm 80mm 90mm calibre paper covers. Most of the paper covers can fit the paper cups circulating in the market. If you have unique needs, we can also customize them for you according to the initial order quantity



2nd Generation Paper Hot Lid



Custom Logo Printed Biodegradable Disposable Paper Coffee Lids



Custom Service Disposable Bagasse Coffee Paper Lid



Rim Roll Paper Hot/Cold Cup Cardbard Lid



Disposable Rim Roll Paper Cardbard Lid for Hot and Cold Cup



Smart Fit Lids

## Paper Cutlery

Disposable paper tableware is undoubtedly the best choice in terms of environmental protection and recyclability. We have disposable ice cream paper spoons, disposable paper knives, disposable paper forks, and consistent paper soup spoons. They are made of compressed cardboard and are very sturdy and durable, they are suitable for queuing, weddings, festivals, fast food, and picnics, bringing more and more convenient choices to your life.



**Wholesale Disposable Takeaway  
Individually Packaged CPLA Cutlery**



**Wholesale Takeaway Disposable  
Food Grade Paper Cutlery**

## CPLA Cutlery

CPLA is made of polylactic acid made of corn and cassava. It is a food-grade safe material. It is compostable and degradable. It is durable and tough during use. It is an ideal choice for your birthday party, takeaway meal, and wedding picnic.

Compostable Cutlery

Paper Cutlery



Item No.	Description	Length(mm)	Pcs/Ctn	Carton Size(mm)	CTNS/20'GP	CTNS/40'HQ
PKF158	158mm Paper Knife Bulk Pack	158x26	3000	370x175x250	1730	4201
PFK158	158mm Paper Fork Bulk Pack	158x31	3000	420x175x280	1361	3304
PSP158	158mm Paper Spoon Bulk Pack	158x36	3000	420x175x280	1361	3304
PKCSP95	95mm Ice Cream Spoon Bulk Pack	95x20	5000	340x200x230	1790	4348
PC2IN1	1 Knife+ 1 Fork	220x100	500	440x340x240	780	1894
PC3IN1A	1 Knife+ 1 Fork+ 1 Napkin	220x100	500	440x340x240	780	1894
PC3IN1B	1 Knife+ 1 Fork+ 1 Spoon	220x100	500	440x340x240	780	1894
PC4IN1	1 Knife+ 1 Fork+ 1 Spoon+ 1 Napkin	220x100	500	440x340x240	780	1894

CPLA Cutlery



Item No.	Description	LengthxWidth(mm)	Pcs/Ctn	Carton Size(mm)	CTNS/20'GP	CTNS/40'HQ
CPLATS4	4" CPLA Teaspoon	95x24	2000	370x280x210	1287	3126
CPLATS5	5" CPLA Teaspoon	124x26	2000	305x254x210	1721	4180
CPLAKF6	6" CPLA Knife	152x16	1000	345x174x126	3702	8990
CPLAFK6	6" CPLA Fork	152x25	1000	345x244x146	2278	5533
CPLASP6	6" CPLA Spoon	152x32	1000	345x244x146	2004	4866
CPLAKF6.5	6.5" CPLA Knife	165x18	1000	345x184x126	3501	8502
CPLAFK6.5	6.5" CPLA Fork	165x27	1000	345x274x166	1784	4333
CPLASP6.5	6.5" CPLA Spoon	165x35	1000	345x274x166	1784	4333
CPLA4IN1-6	6" Pack (1 Knife+ 1 Fork+ 1 Spoon+ 1 Napkin)	210x55	250	470x230x200	1295	3145
CPLA4IN1-6.5	6.5" Pack (1 Knife+ 1 Fork+ 1 Spoon+ 1 Napkin)	210x55	250	470x230x230	1126	2735

# PAPER BAGS

## 纸袋

We provide disposable paper bags for the great food delivery business. There are flat handle paper bags, twist handle paper bags, and die-cut paper bags. They are strong, strong, load-bearing, and support recyclable and renewable. Our engineers will customize the logo for you. Believe that the most suitable for your needs.



Wholesale Environmentally Friendly Shopping Paper Bag



Custom Disposable Food Grade SOS Packaging Brown Kraft Paper Bag



Custom Eco Friendly Disposable Kraft Shopping Paper Bag



Custom Take Out Disposable Brown Kraft Paper Bags

# ALUMINUM PRODUCT

## 铝制品

### HOUSEHOLD ALUMINUM FOILS

Our household aluminum foil is manufactured from high-quality, food-grade aluminum, designed to meet daily cooking, storage, and food protection needs. It offers excellent heat resistance and flexibility, making it suitable for baking, grilling, wrapping, and food preservation.

The foil provides a strong barrier against moisture, light, and odors, helping to maintain food freshness and hygiene. Its durable yet easy-to-handle structure ensures tear resistance while allowing smooth cutting and wrapping.

Available in multiple widths, thicknesses, and roll lengths, our household aluminum foil is suitable for home kitchens as well as hospitality and airline catering preparation areas. Custom packaging and private labeling options are available.

### KEY FEATURES

Food-grade and safe for direct food contact

Heat-resistant and suitable for oven use

Strong, flexible, and tear-resistant

Protects food from moisture and contamination

Available in standard and customized sizes

# ALUMINUM FOIL

## 铝箔卷系列

### Aluminium Foil Roll Series

Country 国家	Size 规格
Germany 德国	14mic*200m*29cm
	14mic*150m*12cm
Guatemala 危地马拉	9mic*7.7m*30cm
	11mic*23m*30cm
	9mic*7.7m*30cm
Honduras 洪都拉斯	12.5mic*31m*30cm
HONGKONG (to USA)	16mic*7.62m*30.5cm
HONGKONG (to USA)	10.5mic*7.62m*30.5cm
India 印度	15mic*40m*13cm
	15mic*40m*14cm
India to USA	12.5mic*304.8m*30cm
Iraq 伊拉克	14mic, 17mic*1.5kg*30cm
	18mic*15m*12cm
	20mic*20m*12cm
	20mic*15m*12cm
	20mic*15m*30cm
	20mic*80m*45cm
	25mic*30m*12cm
	27mic*25m*30cm
	30mic*30m*12cm
	30mic*20m*12cm
	30mic*10m*12cm
	30mic*25m*12cm
	30mic*15m*12cm
	40mic, 45mic, 50mic*3kg*80cm
Israel 以色列	10.5mic*7.5m*30cm
	10.5mic*45cm
	14mic*7.5m*30cm
	14mic*7.5m*45cm
	16mic*60.9m*30cm
	18mic*50*45cm
	18mic*61*30cm
Jamaica 牙买加	15mic*305m*30/45cm
Japan 日本	12mic*50m*30cm
Kazakhstan 哈萨克斯坦	17mic*72m*45cm
Kazakhstan/Turkmenistan 哈萨克斯坦/土库曼斯坦	14mic*100m*45cm

Country 国家	Size 规格
Turkmenistan 土库曼斯坦	10mic*5m*30cm
Kuwait 科威特	10mic*2m*45cm
	10mic*5m*45cm
	12mic*20m*30cm
Lebanon 黎巴嫩	12mic*46.5m*30cm
	12mic*150m*30cm
Libya 利比亚	10mic*100m*30cm
	11mic*10m*37cm
Macedonia 马其顿	12mic*76.8m*30cm
	12mic*51.2m*45cm
Moroco 摩洛哥	13mic*200m*30cm
Netherlands 荷兰	12mic*60.9m*30cm
	12mic*7.62m*30cm
	12mic*22.86m*30cm
	14mic*70m*30cm
Nigeria 尼日利亚	14mic*150m*30cm
	10mic*10m*45cm
	10mic*5m*45cm
	11mic*6m*45cm
	12mic*6m*45cm
	12mic*7m*45cm
	13mic*8m*45cm
	14mic*35m*45cm
15mic*10m*45cm	
North Korea 北朝鲜	15mic*72m*45cm
	15mic*80m*45cm
	39mic*285m*60cm

# ALUMINUM FOIL

## 铝箔卷系列

Aluminium Foil Roll Series

Country 国家	Size 规格
Oman 阿曼	15mic*30m*13cm
Pakistan 巴基斯坦	11mic*4m*30cm
	11mic*8m*30cm
	11mic*8m*45cm
	11mic*30.48m*45cm
	11mic*100m*30cm
	11mic*100m*45cm
	13mic*90m*45cm
	13mic*100m*45cm
	13mic*140m*45cm
	13mic*150m*45cm
	13mic*7.62m*45cm
	16mic*76m*45cm
	16mic*7.62m*45cm
	20mic*7.62m*45cm
	20mic*22.8m*30cm
	20mic*7.62m*30cm
	20mic*7.62m*45cm
	20mic*7.62m*45cm
Palestine 巴勒斯坦	15mic*7.5m*45cm
Panama 巴拿马	12mic*7.62m*30cm
	12mic*22.86m*30cm
	12mic*60.9m*30cm
	12mic*304.8m*30cm
	14mic*7.6m*30cm
	14mic*15.2m*30cm
	14mic*22.8m*30cm
	16mic*7.6m*30cm
	16mic*15.2m*30cm
	16mic*22.8m*30cm

Country 国家	Size 规格
Peru 秘鲁	11mic*5m*30cm
	11mic*8m*30cm
	11mic*10m*30cm
	12.5mic*8m*30cm
Sri Lanka 斯里兰卡	20mic*7.62m*45cm
Sweden 瑞典	11mic*150m*29cm
Syria 叙利亚	19mic*1kg*30cm
	19mic*1kg*45cm
UAE 阿联酋	13mic*130m*30/45cm
	13mic*250m*45cm
UK 英国	10mic*20m*45cm
	10mic*30m*30cm
US 美国	10mic*7.6m*30cm
	10mic*22.8m*30cm
	10mic*60.9m*30cm
Uzbekistan 乌兹别克斯坦	10mic*304m*30cm
	14mic*100m*45cm
	14mic*300m*45cm
	16mic*100m*45cm
	16mic*300m*45cm
Yemen 也门	18mic*300m*45cm
	10mic*10m*30cm
	14mic*10m*30cm
	14mic*140m*30cm
	14mic*150m*30cm
	14mic*75m*30cm
	20mic*100m*45cm
	20mic*180m*30cm
24mic*106m*45cm	
ZA 南非	24mic*160m*30cm
	10mic*50/70m*44cm
	15mic*25m*44cm
	15mic*50/70m*44cm

# ALUMINIUM FOIL

## 铝箔卷系列

Aluminium Foil Roll Series



### 家用餐饮用铝箔卷 Aluminium Foil Roll



铝箔广泛用于食品、饮料、香烟、药品等，通常用作其包装材料。我司主要用于食品包装。铝箔可以有效阻隔热量，湿气，空气和光。我们的铝箔产品采用不含任何有毒元素的优质铝原料制成，并已通过美国FDA检测。铝箔卷的厚度是：9-30mic；最常见的是300mm和450mm，美发箔宽度通常是12 or 15cm；长度：3-300米

包装方式：气泡袋、印刷袋、热缩袋、彩盒。

Aluminium foil is widely used on food ,drinking ,smoke and pharmaceuticals and so on ,usually used as packing material .We use for food packing mostly .Aluminium foil can prevent heat ,water ,air and light .Our aluminium foil product is made of high quality aluminum raw material ,it has passed the FDA certificate .Foil roll thickness range from 9micron to 30micron ;commonly width is 300mm and 450mm ,for hair-dressing salon ,the roll width is 120mm or 150mm ;Length of the foil product ,above 3meters and within 300meter is ok .

Packing methods:bubble bag packing ;pp bag packing with printing ;heat-shrink bag packing and color box packing .

# ALUMINIUM FOIL

## 美发卷系列

Hairdressing Aluminium Foil Series



### POPULAR SPECIFICATION 常用规格

Country 国家	Size 规格
Africa 非洲	14mic*7.62m*30cm
	14mic*22.86m*30cm
	14mic*60.9m*30cm
Albania 阿尔巴尼亚	10mic*5m*30cm
	10mic*85m*30cm
Australia 澳大利亚	11/13/15mic*150m*30/45cm
Bahrain 巴林	11mic*200ft*30cm
	16mic*1.2kg*30cm
	16mic*2kg*30cm
Bangladesh 孟加拉国	15mic*150m*30cm
	18mic*7.62m*45cm
Burkina faso 布基纳法索	15mic*300m*30cm
Cambodia 柬埔寨	19mic*4.5m*30cm
	19mic*6m*45cm
Cameroon 喀麦隆	11mic*170m*30cm
Chile 智利	12mic*7.5m*30cm
	10mic*7.5m*30/45cm
	9mic*100m*30cm

Country 国家	Size 规格
Colombia 哥伦比亚	10mic*7m*30cm
	10mic*16m*30cm
	10mic*40m*30cm
	11mic*100m*30cm
	11mic*300m*30cm
	11mic*21m*30cm
	11mic*40m*30cm
	11mic*100m*30cm
	11mic*300m*30cm
	Dominica 多米尼加
12mic*15.2m*30cm	
12mic*45.7m*30cm	
16mic*213.3m*45cm	
Ecuador 厄瓜多尔	11mic*15m*30cm
	11mic*10m*30cm
	11mic*40m*30cm
	17mic*7.62m*30cm
	17mic*60.9m*30cm
	17mic*150m*30cm
	17mic*7.62m*45cm
	17mic*150m*45cm
	17mic*300m*30cm
	25mic*150m*45cm
Ethiopia 埃塞俄比亚	12mic*300m*30cm
	21mic*4.3m*45cm
France 法国	40mic*5m*60cm
	40mic*5m*80cm
	11mic*30m*30cm
	14mic*31m*30cm

# ALUMINUM FOIL 铝箔



Falcon foil paper aluminum foil roll factory use in kitchen



Travel Bbq Outdoor Household Aluminum Foil For Food



Food Packaging Aluminium Foil Roll Paper For Supermarket



Factory Household Aluminum Foil Roll For Food Wrapping



8011 o household food packing kitchen use aluminum foil



Recyclable Household Kitchen Use 8011 200SQFT Disposable Food Packing Aluminium Foil Roll



Aluminum foil hookah Shisha

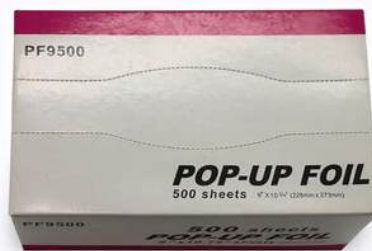

18 Micron Thickness 9 Inch Wide Food Packaging Aluminium Foil Sheet



Manufacturer 10mic~28mic Thickness Aluminum Foil Sheet

# ALUMINUM JUMBO ROLL 铝箔巨型卷



Supplied Wrap Customized Silicone Greaseproof Parchment Baking Paper



Baking Greaseproof Paper Baking Paper Baking Wrapping Paper Jumbo Roll



Silicone coated food grade printed parchment paper burger baking paper



customize logo non stick printed baking parchment paper jumbo roll



wholesale disposable grease proof natural baking paper parchment paper jumbo roll



Food grade baking paper parchment paper jumbo roll



Food packaging PVC cling film jumbo roll film plastic wrap film



Clear Stretch Film Jumbo Roll Plastic Wrap For Pallet Stretch Film Manufacturer



15mic 17mic 20mic PE cling palstic Film Jumbo Roll Plastic Pallet Wrap

# ALUMINUM FOIL BOXES 铝箔盒

**RFE 130**



Top Out: 130x100mm  
Top In: 115x85mm  
Capacity: 230ml  
Base: 95x65mm  
Thickness: 0.05mm(50um)  
Weight: 4g

**RFE 150**



Top Out: 150x120mm  
Top In: 130x110mm  
Capacity: 410ml  
Base: 110x80mm  
Thickness: 0.05mm(50um)  
Weight: 5g

**RFE 185**



Top Out: 185x132mm  
Top In: 169x116mm  
Capacity: 700ml  
Base: 149x100mm  
Thickness: 0.07mm(70um)  
Weight: 9.6g

**RFD 195**



Top Out: 195x144mm  
Top In: 176x125mm  
Capacity: 600ml  
Base: 153x102mm  
Thickness: 0.05mm(50um)  
Weight: 8.7g

**RFF 196**



Top Out: 196x126mm  
Top In: 180x110mm  
Capacity: 700ml  
Base: 153x83mm  
Thickness: 0.05mm(50um)  
Weight: 6.8g

**RFF 200**



Top Out: 200x111mm  
Top In: 182x93mm  
Capacity: 650ml  
Base: 160x69mm  
Thickness: 0.06mm(60um)  
Weight: 8g

**RFE 204**



Top Out: 204x144mm  
Top In: 190x102mm  
Capacity: 580ml  
Base: 175x85mm  
Thickness: 0.05mm(50um)  
Weight: 6g

**RFE 211**



Top Out: 213x143mm  
Top In: 198x128mm  
Capacity: 850ml  
Base: 178x110mm  
Thickness: 0.07mm(70um)  
Weight: 10g

**RFD 217**



Top Out: 218x159mm  
Top In: 201x142mm  
Capacity: 750ml  
Base: 190x127mm  
Thickness: 0.07mm(70um)  
Weight: 11.4g

**RFE 218**



Top Out: 218x126mm  
Top In: 104x110mm  
Capacity: 680ml  
Base: 185x95mm  
Thickness: 0.055mm(55um)  
Weight: 7.2g

**RFF 220**



Top Out: 220x158mm  
Top In: 203x140mm  
Capacity: 1000ml  
Base: 175x115mm  
Thickness: 0.07mm(70um)  
Weight: 13g

**RUE 155**



Top Out: 155x92mm  
Top In: 145x82mm  
Capacity: 430ml  
Base: 125x62mm  
Thickness: 0.065mm(65um)  
Weight: 6.6g

# ALUMINUM FOIL BOXES 铝箔盒

**RFD 230-2**



Top Out: 230x177mm  
 Top In: 215x160mm  
 Capacity: 750ml  
 Base: 200x145mm  
 Thickness: 0.07mm(50um)  
 Weight: 12g

**RFE 204**



Top Out: 204x116mm  
 Top In: 190x102mm  
 Capacity: 580ml  
 Base: 175x85mm  
 Thickness: 0.05mm(50um)  
 Weight: 6g

**RFE 218**



Top Out: 218x126mm  
 Top In: 204x110mm  
 Capacity: 680ml  
 Base: 185x95mm  
 Thickness: 0.055mm(55um)  
 Weight: 7.2g

**RFD 217**



Top Out: 218x159mm  
 Top In: 201x142mm  
 Capacity: 750ml  
 Base: 190x127mm  
 Thickness: 0.07mm(70um)  
 Weight: 11.4g

**RUE 155**



Top Out: 155x95mm  
 Top In: 145x82mm  
 Capacity: 430ml  
 Base: 125x62mm  
 Thickness: 0.065mm(65um)  
 Weight: 6.6g

**RFF 220**



Top Out: 220x158mm  
 Top In: 203x140mm  
 Capacity: 100ml  
 Base: 175x115mm  
 Thickness: 0.07mm(70um)  
 Weight: 13g

**RUE 227-4**



Top Out: 227x179mm  
 Top In: 212x163mm  
 Capacity: 780ml  
 Base: 192x143mm  
 Thickness: 0.06mm(60um)  
 Weight: 14.5g

**RUE 227-3**



Top Out: 227x179mm  
 Top In: 212x163mm  
 Capacity: 780ml  
 Base: 192x143mm  
 Thickness: 0.07mm(70um)  
 Weight: 14.5g

**RUE 227-3A**



Top Out: 233x184mm  
 Top In: 229x180mm  
 Capacity: 100ml  
 Base: 227x180mm  
 Thickness: 0.06mm(60um)  
 Weight: 8g

**RFE 231**



Top Out: 232x173mm  
 Top In: 213x154mm  
 Capacity: 1100ml  
 Base: 200x141mm  
 Thickness: 0.07mm(70um)  
 Weight: 13g

**RFF 250**



Top Out: 250x143mm  
 Top In: 230x124mm  
 Capacity: 1100ml  
 Base: 205x105mm  
 Thickness: 0.08mm(80um)  
 Weight: 16g

**RFH 252**



Top Out: 252x135mm  
 Top In: 236x119mm  
 Capacity: 1500ml  
 Base: 207x85mm  
 Thickness: 0.075mm(75um)  
 Weight: 17g

# ALUMINUM FOIL BOXES 铝箔盒

**RFH 253**



Top Out: 253x197mm  
 Top In: 236x180mm  
 Capacity: 145ml  
 Base: 210x150mm  
 Thickness: 0.07mm(70um)  
 Weight: 14g

**CUD 228**



Top Out: 250x160mm  
 Top In: 215x145mm  
 Capacity: 330ml  
 Base: 210x150mm  
 Thickness: 0.07mm(70um)  
 Weight: 10.4g

**RUG 458**



Top Out: 458x337mm  
 Top In: 420x297mm  
 Capacity: 7000ml  
 Base: 395x273mm  
 Thickness: 0.115mm(115um)  
 Weight: 79g

**TRH 340**



Top Out: 340x230mm  
 Top In: 327x217mm  
 Capacity  
 Base: 315x205mm  
 Thickness: 0.08mm(80um)  
 Weight: 20g



Top Out: 525x328mm  
 Top In: 498x301mm  
 Capacity: 5540ml  
 Base: 472x275mm  
 Thickness: 0.155mm(155um)  
 Weight: 101g

Top Out: 525x328mm  
 Top In: 498x301mm  
 Capacity: 6780ml  
 Base: 464x267mm  
 Thickness: 0.155mm(155um)  
 Weight: 107g

Top Out: 525x328mm  
 Top In: 498x301mm  
 Capacity: 9800ml  
 Base: 453x253mm  
 Thickness: 0.155mm(155um)  
 Weight: 122g

**RFG 260**



Top Out: 260x190mm  
 Top In: 242x172mm  
 Capacity: 1906ml  
 Base: 218x148mm  
 Thickness: 0.07mm(70um)  
 Weight: 18g

**RUI 525A**



Top Out: 526x329mm  
 Base: 539x340mm  
 Thickness: 0.09mm(90um)  
 Weight: 48g



Top Out: 325x262mm  
 Top In: 299x236mm  
 Capacity: 2260ml  
 Base: 275x212mm  
 Thickness: 0.095mm(95um)  
 Weight: 31g

Top Out: 325x262mm  
 Top In: 299x238mm  
 Capacity: 2960ml  
 Base: 265x202mm  
 Thickness: 0.095mm(95um)  
 Weight: 34g



Top Out: 325x262mm  
 Top In: 299x238mm  
 Capacity: 2960ml  
 Base: 265x202mm  
 Thickness: 0.095mm(95um)  
 Weight: 34g

**RUG 325A**



Top Out: 326x263mm  
 Base: 338x275mm  
 Thickness: 0.09mm(90um)  
 Weight: 20.5g

# ALUMINUM FOIL BOXES 铝箔盒

**CUD 228**

Top Out: 228 mm  
Top In: 207 mm  
Capacity: 960ml  
Base: 166 mm  
Thickness: 0.07mm (70um)  
Weight: 11g

**CUC 201**

Top Out: 200 mm  
Top In: 186 mm  
Capacity: 500ml  
Base: 76 mm  
Thickness: 0.055mm (55um)  
Weight: 6.9g

**CUB 295**

Top Out: 295 mm  
Top In: 275 mm  
Capacity: 960ml  
Base: 66 mm  
Thickness: 0.065mm (65um)  
Weight: 14.4g

**IUH 445**

Top Out: 445X355 mm  
Top In: 408X318 mm  
Capacity: 6600ml  
Base: 350X245 mm  
Thickness: 0.10mm (100um)  
Weight: 68g

**POF 257**

Top Out: 257X177 mm  
Top In: 240X165 mm  
Capacity: 7200ml  
Base: 350X245 mm  
Thickness: 0.08mm (80um)  
Weight: 10g

**OUH 468**

Top Out: 468X340 mm  
Top In: 440X313 mm  
Capacity: 7200ml  
Base: 380X265 mm  
Thickness: 0.12mm (120um)  
Weight: 68g

**CFH 232**

Top Out: 82 mm  
Top In: 71 mm  
Capacity: 115ml  
Base: 55 mm  
Thickness: 0.07mm (70um)  
Weight: 17g

**CFE 212**

Top Out: 215 mm  
Top In: 198 mm  
Capacity: 1100ml  
Base: 175 mm  
Thickness: 0.07mm (70um)  
Weight: 12g

**IUH 445**

Top Out: 445X355 mm  
Top In: 408X318 mm  
Capacity: 6600ml  
Base: 350X265 mm  
Thickness: 0.10mm (100um)  
Weight: 68g

**Y8237**

Top Out: 232 mm  
Top In: 215 mm  
Capacity: 1900ml  
Base: 185 mm  
Thickness: 0.045mm (45um)  
Weight: 2g

**Y38040**

Top Out: 380 mm  
Top In: 360 mm  
Capacity: 900ml  
Base: 175 mm  
Thickness: 0.17mm (170um)  
Weight: 70g



# ALUMINUM FOIL BOXES 铝箔盒

**F15830**



Top Out: 158X101 mm  
 Top In: 147X89X29mm  
 Capacity: 350ml  
 Base: 140X82mm  
 Thickness: 0.088mm(88um)  
 Weight: 7.8g

**F15931**



Top Out: 165X100mm  
 Top In: 156X91X32mm  
 Capacity: 340ml  
 Base: 121X56mm  
 Thickness: 0.085mm(85um)  
 Weight: 6.4g

**F15931**



Top Out: 133X102 mm  
 Top In: 123X92X28mm  
 Capacity: 220ml  
 Base: 103X72mm  
 Thickness: 0.09mm(90um)  
 Weight: 6.1g

**F15931**



Top Out: 159X101X31 mm  
 Top In: 147X89X27mm  
 Capacity: 330ml  
 Base: 135X82mm  
 Thickness: 0.1mm(100um)  
 Weight: 7.8g

**G19016-L**



Top Out: 190X109X16 mm  
 Top In: 165X90mm  
 Thickness: 0.06mm(60um)  
 Weight: 4.6g

**G18211**



Top Out: 182X105 mm  
 Top In: 155X102X6mm  
 Thickness: 0.06mm(60um)  
 Weight: 4.6g

**F15931**



Top Out: 159X101X31 mm  
 Top In: 147X89X27mm  
 Capacity: 330ml  
 Base: 135X82mm  
 Thickness: 0.1mm(100um)  
 Weight: 7.8g



# ALUMINUM FOIL BOXES 铝箔盒

**F9730**

Top Out: 97x72 mm  
 Top In: 86x61 mm  
 Capacity: 135ml  
 Base: 78x53 mm  
 Thickness: 0.12mm (120um)  
 Weight: 4.6g

**F16030**

Top Out: 160x110 mm  
 Top In: 148x100 mm  
 Capacity: 135ml  
 Base: 137x90 mm  
 Thickness: 0.1mm (100um)  
 Weight: 10.6g

**F16030**

Top Out: 99x99x40 mm  
 Top In: 90x90 mm  
 Capacity: 135ml  
 Base: 68x68 mm  
 Thickness: 0.1mm (100um)  
 Weight: 4.5g



# ALUMINUM FOIL BOXES 铝箔盒

@ELITE-SUPPLIES

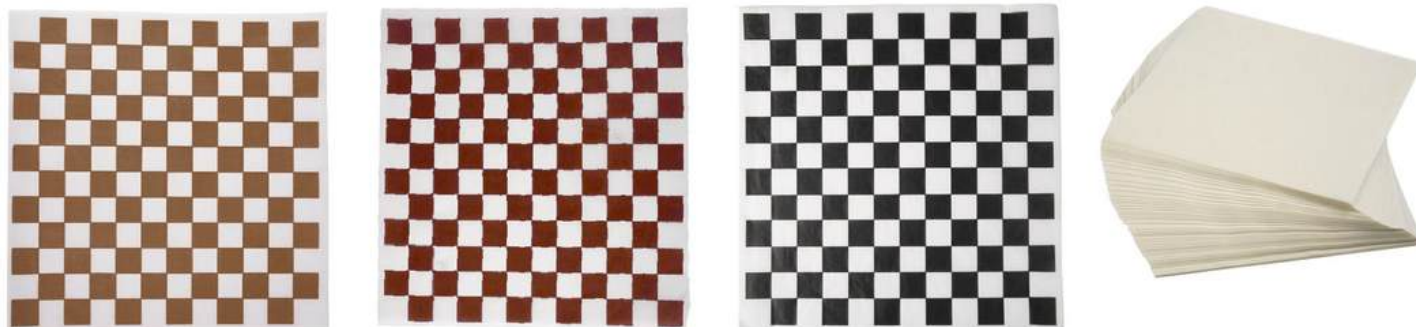

我司生产的蜡纸采用100%进口木浆，双面食品级橄榄蜡涂层。纸面光滑细腻，重复使用率高，广泛应用于各类食品包装。

我们能提供各种规格的大卷、小卷、平张纸，并可以提供4色印刷。

Wax paper used to wrap foods to preserve freshness and as a liner for various baking dishes for hot and cold prepared food .

## Advantages:

- 1.Provides grease and moisture resistance.
  - 2.Makes the food items look appetizing when it is served.
  - 3.Makes food presentation easier with less clean up.
  - 4.Preserves take-out freshness.
  - 5.Enhances presentation of the food items.
- \*We can offer jumbo roll.retail pack roll or wax paper sheet.  
\*we can offer 4 colors food grade printing.

# ALUMINUM FOIL BOXES 铝箔盒

## Plastic Wrap



@ELITE-SUPPLIES



# WAX PAPER



Food grade non-stick wax paper patty paper



Custom Color Printed Paper Food Wrapping Burger Packaging Wax



Design Color Printable One Side Wax Coated Cheap Waxed Paper



31g White Food Wrapping Paper Wax Paper Manufacture



Greaseproof Non-stick Food Packaging grease proof Wax Paper Roll



Multipurpose Wax Paper Perfect Companion for Baking, Wrapping, and Art Creations

# BACKING PAPER



Brown Food Wrapping Use Greaseproof Baking Paper Parchment Paper



Customize Logo Non Stick Printed Baking Parchment Paper Sheet



Customize Logo Non Stick Printed Baking Parchment Paper Sheet



Pre Cut Baking Paper And Greaseproof Paper Greaseproof Paper



40 gsm silicon coated Paper Wrapping Paper Sheet



Non-stick Silicone Baking Mat Baking Sheet Baking Paper

# ALUMINUM FOIL



Colorful Cardboard Boxes Customized Cardboard Boxes Folding Cardboard Boxes



Aluminium Foil Kitchen Roll with Plastic Cutting Blade



Plastic Core Holder for Cling Film Food Wrap Aluminum Foil Fixing Plug

# Company Profile CERTIFICATION



BRC



BSCI



FSC



ABA (Aqueous Coated)



DIN CERTCO (Aqueous Coated)



DIN CERTCO (PLA Coated)



BPI (PLA Coated)



Component Analysis-FTIR (Aqueous Coated Paper Cup)



EU Test Report (PLA Coated Paper Cup)



FDA Test Report (PLA Coated Paper Cup)



EU Test Report (PE Coated Paper Cup)



FDA Test Report (PE Coated Paper Cup)

Company Profile

# CERTIFICATION



BRC	BSCI	LFGB	FDA	Sedex	ISO	Custom certificate	PHYTOSANITARY
Yes	Yes	Yes	Yes	Yes	Yes	CO/FORM A/FORM E/FORM L/FUMIGATION	Yes





**CALL US NOW.**

立即拨打



+86 152 1095 8547, +971 54 304 7155



admin@vsource.me



www.vsource.me



Office 689, Albarsha First Building, Dubai, UAE.



**Compostable**

We champion composting & biodegradable material as the best recycling solution for food packaging



**Plant-based**

Made from a variety of plant-based materials: bamboo | wooden | bagasse. Designed for the circular economy where resources.



**100% Carbon Neutral**

Made from a variety of plant-based materials: bamboo | wooden | bagasse. Designed for the circular economy where resources.



**Sustainable**

JFB is committed to the concept of sustainable development, and the materials of its products are all natural



**Durable**

After many R&D tests, the product has good stability, high temperature resistance and durability